

Isaro Pro

THORN

96636172 IP 24L105-740 NR BP 3550 CL2 M60 GY-S



Isaro Pro

A state of the art LED road lighting lantern (small) with 24 LEDs driven at 1050mA with Narrow Road optic. Programmable LED driver. Class II electrical (this product is not earthed), IP66, IK09. Housing: die-cast aluminium (EN AC-44300), powder coated textured light grey 150 (close to RAL9006). Spigot: die-cast aluminium (EN AC-44300), unpainted. Enclosure: 5mm thick glass. Fixings: spring steel. Supplied with Ø60mm spigot adaptor which can be fitted for post-top (0°/5°/10°/15°/20° tilt) or side-entry (-15°/-10°/-5°/0°/5°/10°/15° tilt). Equipped with 50% power reduction circuit, effective 3 hours before and 5 hours after a calculated midnight. Complete with 4000K LED. Surge protection: 10kV single pulse common mode and 8kV multipulse common mode and 6kV multipulse differential mode. If permanent DALI system is connected, 6kV multipulse common and differential mode.

Dimensions: 571 x 224 x 114 mm
Luminaire input power: 78.5 W
Luminaire luminous flux: 10936 lm
Luminaire efficacy: 139 lm/W
Weight: 5.33 kg
Scx: 0.054 m²



TLG_ISRP_F_PDB_SIL.jpg

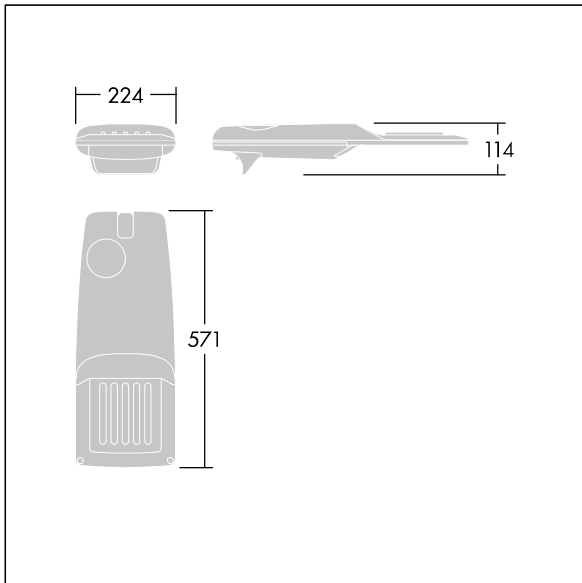

TLG_ISRP_M_LD1.wmf

This product contains a light source of energy efficiency class D.

All values marked with an * are rated values. Thorn uses tried and tested components from leading suppliers, however there may be isolated instances of technology-related failures of individual LEDs during the rated product lifetime. International standards set the tolerance in initial flux and connected load at ±10%. Unless stated otherwise, the values apply to an ambient temperature of 25°C.

Thorn Lighting is constantly developing and improving its products. The right is reserved to change specifications without prior notification or public announcement.
© Thorn Lighting

Isaro Pro

96636172 IP 24L105-740 NR BP 3550 CL2 M60 GY-S

THORN