

# Urba

# THORN

96671777 UA 60L50-740 NR CL2 T60E ANT

ISO 9223	C3	IP66	IK09						
----------	----	------	------	--	--	--	--	--	--

## Urba

A large size LED urban street lighting lantern with 60 LEDs driven at 500mA with narrow road optic. Electronic, fixed output control gear. Class II electrical (this product is not earthed), IP66, Surge protection: 10kV single pulse common mode and 8kV multipulse common mode and 6kV multipulse differential mode. If permanent DALI system is connected, 6kV multipulse common and differential mode.. Body: die-cast aluminium (EN AC-44300), textured anthracite. Cover: tempered flat clear glass. Fixings: stainless steel with anti-galvanic treatment. Post top mounting to Ø60mm column. Complete with 4000K LED.

Dimensions: 1078 x 400 x 357 mm  
Luminaire input power: 89 W  
Weight: 16 kg  
Scx: 0.11 m<sup>2</sup>



TLG\_URBA\_F\_LMTPGYPDB.jpg

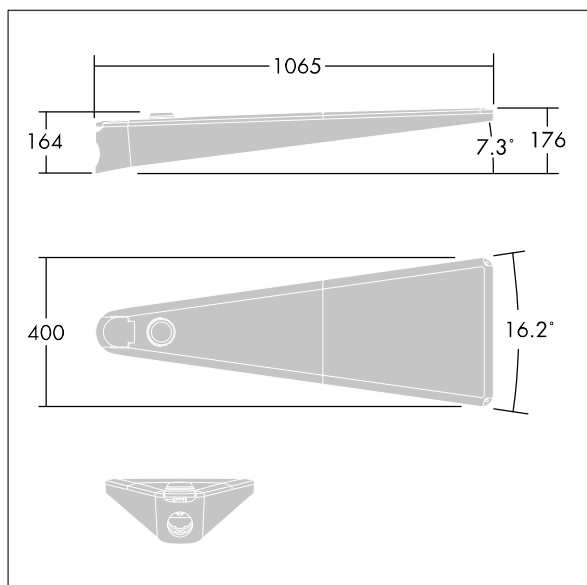

TLG\_URBA\_M\_LD1.wmf

This product contains light sources of energy efficiency class D.

All values marked with an \* are rated values. Thorn uses tried and tested components from leading suppliers, however there may be isolated instances of technology-related failures of individual LEDs during the rated product lifetime. International standards set the tolerance in initial flux and connected load at ±10%. Unless stated otherwise, the values apply to an ambient temperature of 25°C.

Thorn Lighting is constantly developing and improving its products. The right is reserved to change specifications without prior notification or public announcement.  
© Thorn Lighting

**Urba**

**96671777 UA 60L50-740 NR CL2 T60E ANT**

**THORN**