

# Thor

# THORN

96635463 TR 24L35-740 NR CL1 FD T60E ANT

ISO 9223 C5		IP66	IK10					T <sub>a</sub> 25
----------------	---	------	------	---	---	---	---	-------------------

## Thor

A small size, smart urban LED lantern with 24 LEDs driven at 350mA with narrow road optic and die-cast aluminium EN AC 47100 + CAT dome with anthracite finish (close to RAL7043). Class I electrical, IP66, IK10. Body: die-cast aluminium (EN AC 47100 + CAT) treated against corrosion, powder coated anthracite (close to RAL7043), bracket: die-cast aluminium (EN AC-47100 + CAT) treated against corrosion, powder coated anthracite (close to RAL7043). Enclosure: 6mm toughened flat glass. Screws and closing set: stainless steel. Post top mounting to Ø60mm column, tilt 0°, adjustable from -15° to +10°. Complete with 4000K LED.

Dimensions: 618 x 459 x 251 mm  
Luminaire input power: 28 W  
Luminaire luminous flux: 4139 lm  
Luminaire efficacy: 148 lm/W  
Weight: 8.8 kg  
Scx: 0.038 m<sup>2</sup>



TLG\_THOR\_F\_SMTFFD.jpg

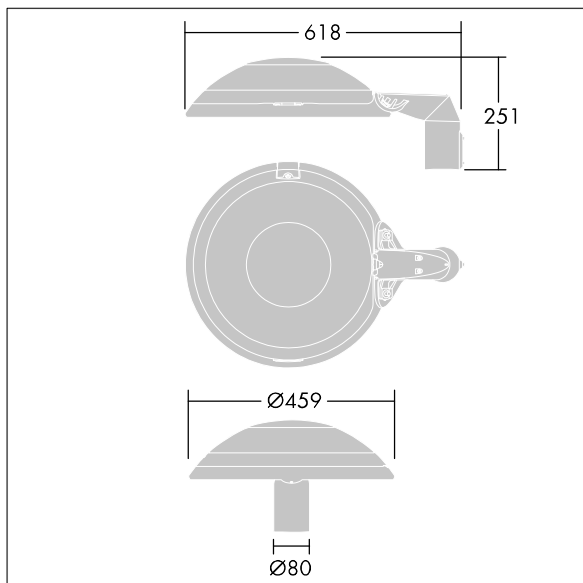

TLG\_THOR\_M\_MTP.wmf

This product contains a light source of energy efficiency class D.

All values marked with an \* are rated values. Thorn uses tried and tested components from leading suppliers, however there may be isolated instances of technology-related failures of individual LEDs during the rated product lifetime. International standards set the tolerance in initial flux and connected load at ±10%. Unless stated otherwise, the values apply to an ambient temperature of 25°C.

Thorn Lighting is constantly developing and improving its products. The right is reserved to change specifications without prior notification or public announcement.  
© Thorn Lighting

**Thor**

**96635463 TR 24L35-740 NR CL1 FD T60E ANT**

**THORN**