

96632775 ARS 18L50-740 RS CL-D CL2 W5 T60 ANT



Aerie

A discreet, post top LED lantern with a timeless design. LED driver for 18 LEDs, driven at 500mA with radially symmetric distribution. Class II electrical (this product is not earthed), IP66, IK10. Canopy and base: corrosion resistant die-cast powder coated aluminium suitable for C5 environments, finished textured anthracite (close to RAL7043). Enclosure: slim UV stabilised polycarbonate with clear finish. Fitted with internal diffuser to reduce glare. Complete with 4000K LED. Post top mounting to Ø60mm column. Pre-wired with 5m cable.

Dimensions: Ø602 x 586 mm
 Luminaire input power: 28 W
 Luminaire luminous flux: 3703 lm
 Luminaire efficacy: 132 lm/W
 Weight: 11.07 kg
 Scx: 0.172 m²



TLG_AERI_F_S_PR_CL.jpg

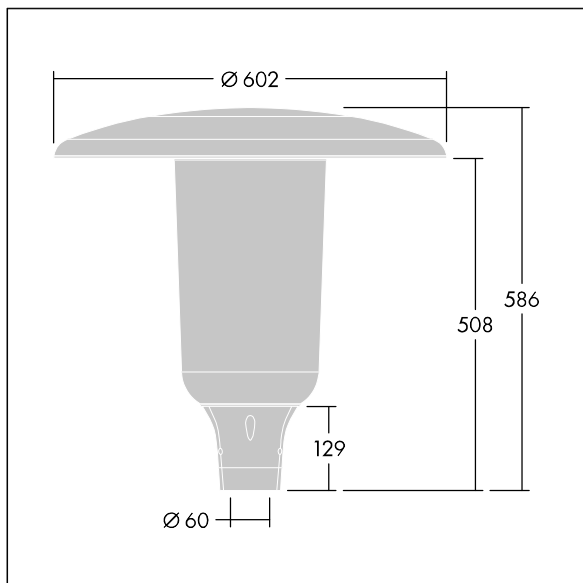

TLG_AERI_M_T60_S.wmf

This product contains a light source of energy efficiency class D.

All values marked with an * are rated values. Thorn uses tried and tested components from leading suppliers, however there may be isolated instances of technology-related failures of individual LEDs during the rated product lifetime. International standards set the tolerance in initial flux and connected load at ±10%. Unless stated otherwise, the values apply to an ambient temperature of 25°C.

Aerie

96632775 ARS 18L50-740 RS CL-D CL2 W5 T60 ANT

THORN