

# EP 445

96631767 EP445 36L70-827 ND-A BPS CL2 MSU

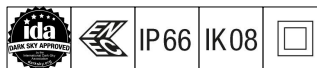

## EP 445

A 19th Century style lantern with 36 LEDs with switchable drive current and Narrow Road optic. Equipped with power reduction circuit, profile selected by rotary switch. Class II electrical (this product is not earthed), IP66, IK08. Body: die-cast aluminium, painted black (close to RAL9005) textured. Enclosure: 4mm thick extra clear glass. Complete with 2700K LED

Dimensions: 436 x 436 x 725 mm

Luminaire input power: 78 W

Weight: 8.7 kg

Scx: 0.19 m<sup>2</sup>



TLG\_EP44\_F\_MSU.jpg

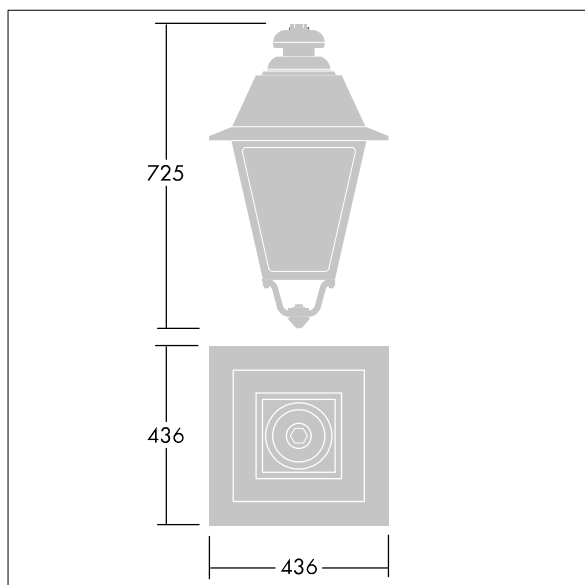

TLG\_EP44\_M\_SUS.wmf

This product contains a light source of energy efficiency class E.