

Areaflood Pro

96644770 AFP S 36L35-740 A4 BS 3550 CL1 GY

ISO 9223 C5		IP66	IK08					T _a -25 +35
----------------	--	------	------	--	--	--	--	---------------------------

Areaflood Pro

A compact, lightweight, general purpose LED area floodlight. With small body, driving 36 LEDs at 350mA with asymmetrical 40° light distribution. IP66, IK08, Class I electrical. Body: die-cast aluminium (EN AC-44300), Light grey 150 sanded textured (close to RAL9006).. Enclosure: 4mm thick toughened glass. Reversible mounting stirrup supplied, Complete with 4000K LED.

Not compatible with UrbaSens systems.

Dimensions: 462 x 265 x 139 mm
 Luminaire input power: 39 W
 Luminaire luminous flux: 6379 lm
 Luminaire efficacy: 164 lm/W
 weight: 6.3 kg
 Scx: 0.05 m²



TLG_AFLP_F_SMALLPDB.jpg

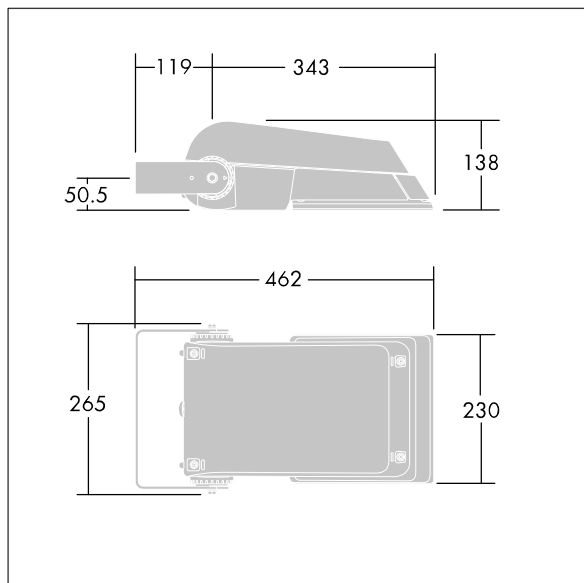

TLG_AFLP_M_SML.wmf

This product contains light sources of energy efficiency class E.

All values marked with an * are rated values. Thorn uses tried and tested components from leading suppliers, however there may be isolated instances of technology-related failures of individual LEDs during the rated product lifetime. International standards set the tolerance in initial flux and connected load at ±10%. Unless stated otherwise, the values apply to an ambient temperature of 25°C.

Areaflood Pro

96644770 AFP S 36L35-740 A4 BS 3550 CL1 GY

THORN