

Royal Elite

THORN

96652787 ROYAL ELITE LED4500-940 12X3 HF FP



Royal Elite

Royal Elite is a high performance recessed LED modular luminaire. Fixed output LED driver. Body: white painted aluminium frame. Diffuser: High uniformity microprismatic, UGR<19. Suitable for Office, Retail and School applications. Class II electrical (this product is not earthed), IP44_IP20. Electrical connection: Fitted with flex and plug. Complete with 4000K LED, CRI95+, R9 80+, 2 Step MacAdam LED

This product has a Cyanosis Observation Index (COI) of less than 3.3, in accordance with AS/NZS 1680.2.5:1997 for hospitals and medical tasks.

Dimensions: 1196 x 296 x 33 mm
Luminaire input power: 41 W
Luminaire luminous flux: 4887 lm
Luminaire efficacy: 119 lm/W
Weight: 4 kg



TLG_RYLL_F_02.jpg

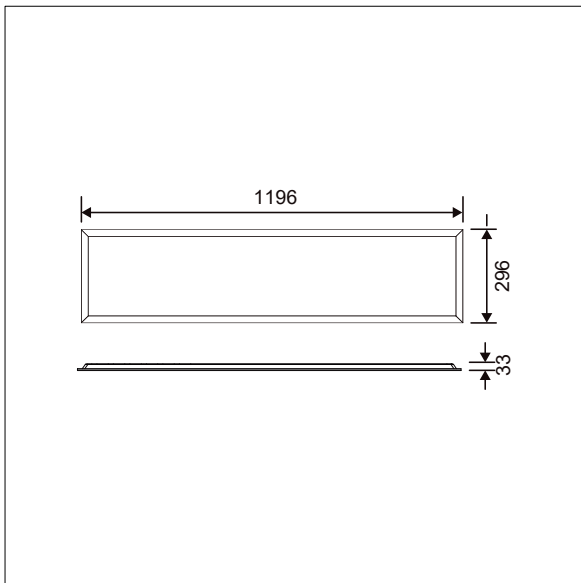

TLG_RYLL_M_123_LD.wmf

All values marked with an * are rated values. Thorn uses tried and tested components from leading suppliers, however there may be isolated instances of technology-related failures of individual LEDs during the rated product lifetime. International standards set the tolerance in initial flux and connected load at $\pm 10\%$. Unless stated otherwise, the values apply to an ambient temperature of 25°C.

Thorn Lighting is constantly developing and improving its products. The right is reserved to change specifications without prior notification or public announcement.
© Thorn Lighting

Royal Elite

96652787 ROYAL ELITE LED4500-940 12X3 HF FP

THORN