

Candle

96679080 CN 18L50 730 RSC CL2 W3 ANT

ISO 9223 C5	IP66	IK10				T _a 25
----------------	------	------	--	--	--	-------------------

Candle

Slim lighting column with 18 LEDs driven at 500mA with Radial symmetrical comfort light distribution. Fixed output LED driver. Class II electrical (this product is not earthed), IP66, IK10. Base: die-cast aluminium (EN AC-44300). Finish: powder coated aluminium, texturized anthracite (close to RAL7043). Diffuser: UV stabilised clear polycarbonate. Pre-wired with 3m cable. Column to be ordered separately. Complete with 3000K LED.

Dimensions: Ø234 x 559 mm
 Luminaire input power: 27.9 W
 Weight: 4.84 kg
 Scx: 0.06 m²
 Luminaire efficacy: 115 lm/W



TLG_CNDL_F_2.jpg

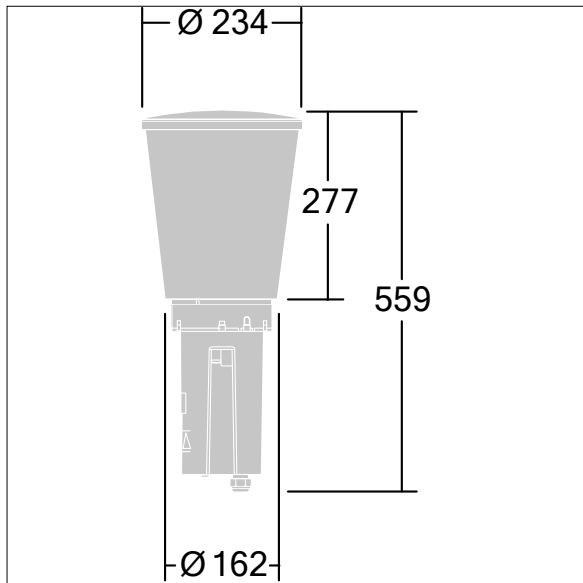

TLG_CNDL_M_HEAD.wmf

This product contains a light source of energy efficiency class D.

All values marked with an * are rated values. Thorn uses tried and tested components from leading suppliers, however there may be isolated instances of technology-related failures of individual LEDs during the rated product lifetime. International standards set the tolerance in initial flux and connected load at ±10%. Unless stated otherwise, the values apply to an ambient temperature of 25°C.