

Lucem

THORN

96651815 LUCEM S LED1100-940 HF WH

ISO 9223 C4	IP65	IK06	⊕	⊕	
----------------	------	------	---	---	--

Lucem

An architectural LED wall mounted luminaire with asymmetric light distribution, particularly suitable for indirect lighting applications. Electronic, fixed output control gear. Class I electrical, IP65, IK06. Body: die-cast aluminium (EN AB-47100), powder coated textured white (close to RAL9010). Supplied in one box, ready to install. Complete with 4000K LED.

Dimensions: 160 x 139 x 58 mm
Luminaire input power: 12.4 W
Luminaire luminous flux: 1145 lm
Luminaire efficacy: 92 lm/W
Weight: 2 kg



TLG_LUCEM_F_S.jpg

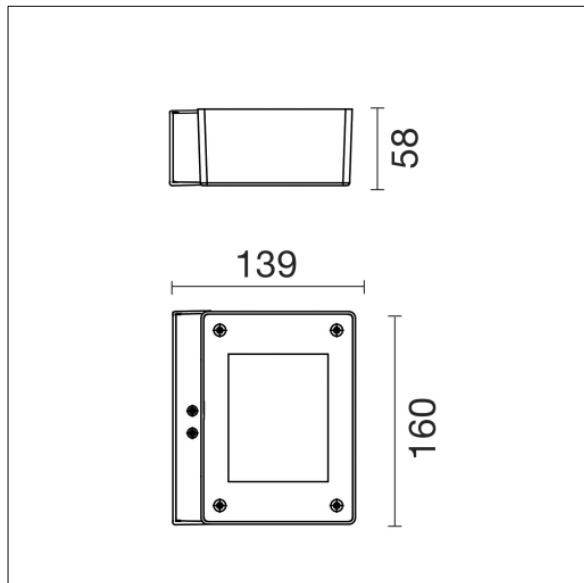

TLG_LUCEM_M_S.wmf

All values marked with an * are rated values. Thorn uses tried and tested components from leading suppliers, however there may be isolated instances of technology-related failures of individual LEDs during the rated product lifetime. International standards set the tolerance in initial flux and connected load at $\pm 10\%$. Unless stated otherwise, the values apply to an ambient temperature of 25°C.

Thorn Lighting is constantly developing and improving its products. The right is reserved to change specifications without prior notification or public announcement.
© Thorn Lighting