

Urba Deco

THORN

96279233 UD 24L50 730 WSC-S CL2 WS1 MCA-T BK U0



Urba Deco

A smart, sophisticated architectural urban lantern with 24 LEDs driven at 500mA and a Wide Street Comfort (symmetrical) optic with no upward light. Electronic, fixed output control gear. Class II electrical (this product is not earthed), IP66, Impact strength: IK10. Canopy and base: die-cast aluminium (AS9U3, LM24 equivalent, EN AC-46000) textured black (close to RAL9005). Enclosure: 6mm thick clear glass. Pre-wired with 1m cable. Catenary mounted through 34G, luminaire perpendicular to the road. Complete with 3000K LED.

Surge protection: 10kV single pulse common mode and 8kV multipulse common mode and 6kV multipulse differential mode. If permanent DALI system is connected, 6kV multipulse common and differential mode.

Dimensions: 510 x 241 x 266 mm
Luminaire input power: 37 W
Luminaire luminous flux: 5066 lm
Luminaire efficacy: 137 lm/W
Weight: 7.07 kg
Scx: 0.031 m²



TLG_URBD_F_MCA.jpg

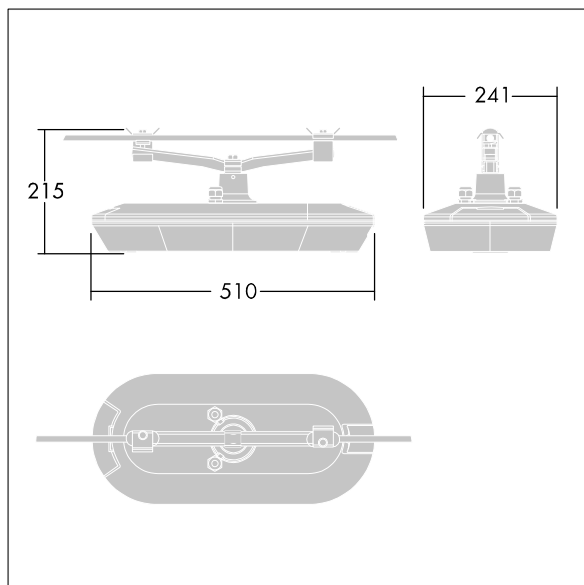

TLG_URBD_M_CATENARY.wmf

All values marked with an * are rated values. Thorn uses tried and tested components from leading suppliers, however there may be isolated instances of technology-related failures of individual LEDs during the rated product lifetime. International standards set the tolerance in initial flux and connected load at $\pm 10\%$. Unless stated otherwise, the values apply to an ambient temperature of 25°C.

Thorn Lighting is constantly developing and improving its products. The right is reserved to change specifications without prior notification or public announcement.
© Thorn Lighting

Urba Deco

96279233 UD 24L50 730 WSC-S CL2 WS1 MCA-T BK U0

THORN