

# Urba Deco

# THORN

96279228 UD 48L50-730 WSC-S CL1 WS1 MSU-T BK U0



## Urba Deco

A smart, sophisticated architectural urban lantern with 48 LEDs driven at 500mA and a Wide Street Comfort (symmetrical) optic with no upward light. Electronic, fixed output control gear. Class I electrical, IP66, Impact strength: IK09. Canopy and base: die-cast aluminium (AS9U3, LM24 equivalent, EN AC-46000) textured black (close to RAL9005). Enclosure: 6mm thick clear glass. Pre-wired with 1m cable. Suspended through 34G, luminaire perpendicular to the road. Complete with 3000K LED.

Surge protection: 10kV single pulse common mode and 8kV multipulse common mode and 6kV multipulse differential mode. If permanent DALI system is connected, 6kV multipulse common and differential mode.

Dimensions: 510 x 241 x 146 mm  
Luminaire input power: 69.8 W  
Luminaire luminous flux: 10642 lm  
Luminaire efficacy: 152 lm/W  
Weight: 6.53 kg  
Scx: 0.031 m<sup>2</sup>



TLG\_URBD\_F\_MSUPDB.jpg

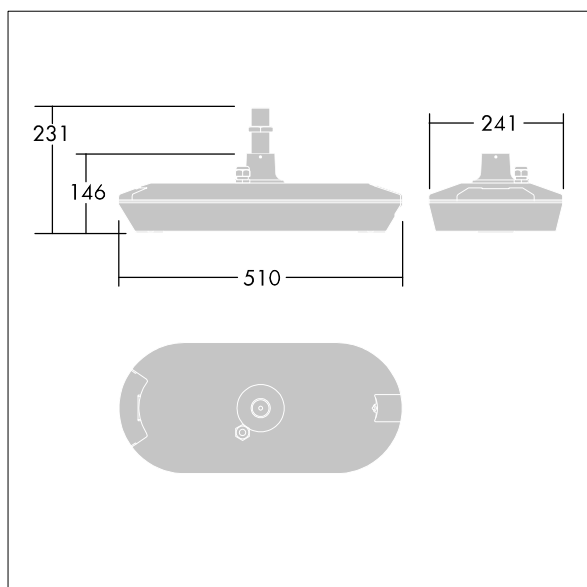

TLG\_URBD\_M\_MUS.wmf

All values marked with an \* are rated values. Thorn uses tried and tested components from leading suppliers, however there may be isolated instances of technology-related failures of individual LEDs during the rated product lifetime. International standards set the tolerance in initial flux and connected load at  $\pm 10\%$ . Unless stated otherwise, the values apply to an ambient temperature of 25°C.

Thorn Lighting is constantly developing and improving its products. The right is reserved to change specifications without prior notification or public announcement.  
© Thorn Lighting

# Urba Deco

96279228 UD 48L50-730 WSC-S CL1 WS1 MSU-T BK U0

THORN