

96668681 PLI O 24L60-740 R/S BS 3550 T60 CL2 ANT



Plurio

Plurio Indirect: A decorative post-top LED lantern with radially symmetric distribution. LED driver with 24 LEDs driven at 600mA. Class II electrical (this product is not earthed), IP66, IK08. Base: cast aluminium, powder coated anthracite (close to RAL7043). Canopy: original shape, aluminium, textured anthracite (close to RAL7043). Diffuser: UV stabilised, clear polycarbonate with anti-glare prisms. Indirect, reflector based optic. Equipped with 50% power reduction circuit, effective 3 hours before and 5 hours after a calculated midnight. It can be deactivated at installation with an easily accessible internal switch. Complete with 4000K LED. Post top mounting to Ø60mm column.

Upward lighting emissions below 1%.

Dimensions: Ø564 x 567 mm
 Luminaire input power: 44 W
 Luminaire luminous flux: 5206 lm
 Luminaire efficacy: 118 lm/W
 Weight: 9.5 kg
 Scx: 0.199 m²



TLG_PLRL_F_IOC_ANT.jpg

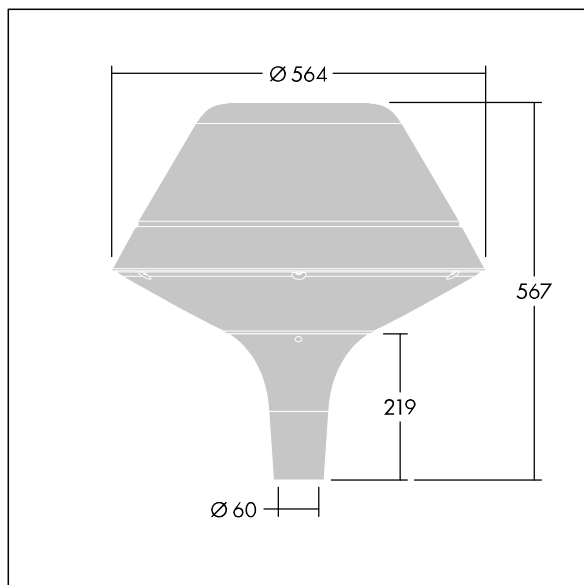

TLG_PLRL_M_IOC_T60.wmf

This product contains a light source of energy efficiency class D.

Plurio

96668681 PLI O 24L60-740 R/S BS 3550 T60 CL2 ANT

THORN