

ISO 9223 C5			IP66		IK08						T _a 25
----------------	--	--	------	--	------	--	--	--	--	--	-------------------

Plurio

Plurio Indirect: A decorative post-top LED lantern with radially symmetric distribution. LED driver with 24 LEDs driven at 600mA. Class II electrical (this product is not earthed), IP66, IK08. Base: cast aluminium, powder coated anthracite (close to RAL7043). Canopy: disc shape, aluminium, textured anthracite (close to RAL7043). Diffuser: UV stabilised, clear polycarbonate with anti-glare prisms. Indirect, reflector based optic. Equipped with 50% power reduction circuit, effective 3 hours before and 5 hours after a calculated midnight. It can be deactivated at installation with an easily accessible internal switch. Complete with 4000K LED. Post top mounting to Ø60mm column.

Upward lighting emissions below 1%.

Dimensions: Ø618 x 453 mm
 Luminaire input power: 44 W
 Luminaire luminous flux: 5206 lm
 Luminaire efficacy: 118 lm/W
 Weight: 11 kg
 Scx: 0.151 m²



TLG_PLRL_F_IDC_ANT.jpg

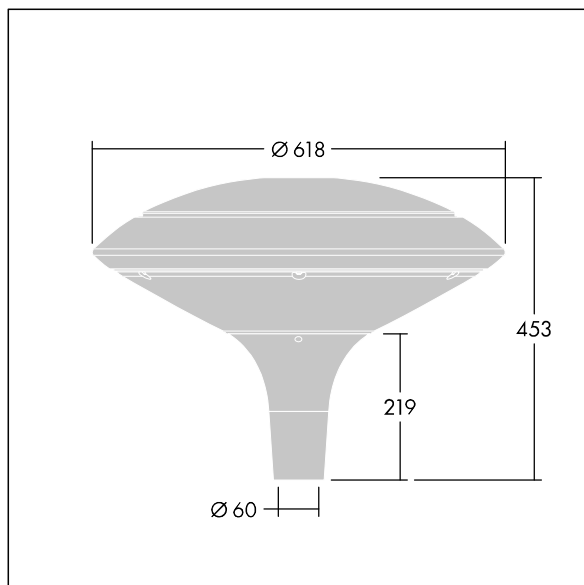

TLG_PLRL_M_IDC_T60.wmf

This product contains a light source of energy efficiency class D.