

# Plurio

# THORN

96668621 PLI F 24L70-722-40 R/S T60 CL2 ANT

ISO 9223 C5		IP66 IK08					T <sub>a</sub> 25
----------------	---	-----------	---	---	---	---	-------------------

## Plurio

Plurio Indirect: A decorative post-top LED lantern with radially symmetric distribution. LED driver with 24 LEDs driven at 700mA. Class II electrical (this product is not earthed), IP66, IK08. Base: cast aluminium, powder coated anthracite (close to RAL7043). Canopy: flat shape, aluminium, textured anthracite (close to RAL7043). Diffuser: UV stabilised, clear polycarbonate with anti-glare prisms. Indirect, reflector based optic. Complete with 2200-4000K NightTune LEDs. Post top mounting to Ø60mm column.

Upward lighting emissions below 1%.

Dimensions: Ø601 x 487 mm  
Luminaire input power: 51 W  
Luminaire luminous flux: 5386 lm  
Luminaire efficacy: 106 lm/W  
Weight: 11 kg  
Scx: 0.167 m<sup>2</sup>



TLG\_PLRL\_F\_IFC\_ANT.jpg

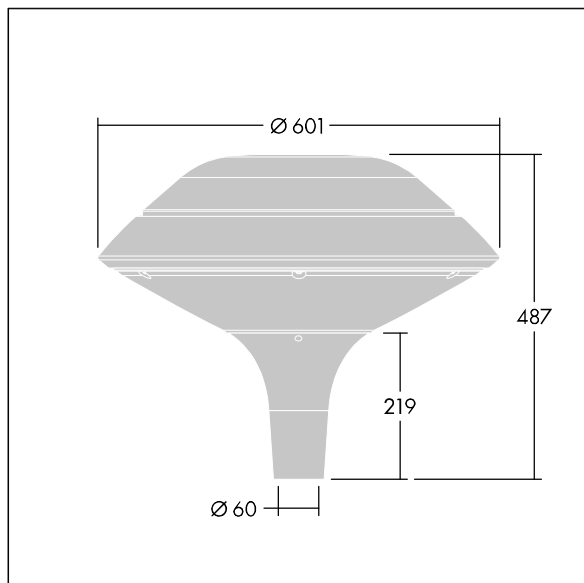

TLG\_PLRL\_M\_IFC\_T60.wmf

This product contains a light source of energy efficiency class D.

All values marked with an \* are rated values. Thorn uses tried and tested components from leading suppliers, however there may be isolated instances of technology-related failures of individual LEDs during the rated product lifetime. International standards set the tolerance in initial flux and connected load at ±10%. Unless stated otherwise, the values apply to an ambient temperature of 25°C.

Thorn Lighting is constantly developing and improving its products. The right is reserved to change specifications without prior notification or public announcement.  
© Thorn Lighting