

Chalice 74

THORN

96631505 CHAL 74 LED900-830 WFL IP65 WHM

RoHS	T _a 0 +40	IP ₂₀ 65	IK04					650 °C
------	-------------------------	------------------------	------	--	--	--	--	--------

Chalice 74

A ceiling recessed, fire-rated, LED downlight. Integral LED driver, suitable for use with leading edge dimmer switches. IP65 (IP20 from above), IK04, Class II electrical (this product is not earthed). Supplied with wide flood (48°) PMMA lens and matt die-cast aluminium bezel. Body: steel with aluminium heatsink. Spring clips make the product suitable for tool-free mounting in ceiling thicknesses of 1-25mm in a Ø74-80mm cutout. Tool-free wiring with a fully detachable connector and push-fit terminal block enabling loop-in/loop-out. Complete with 3000K LED. Fully fire rated for 30, 60 and 90 minute ceilings.

Adaptable light distribution by exchanging the WFL (48°) lens with either FL (31°) or WW (wallwash optic) - available as accessories.

Adaptable aesthetics by exchanging the WHM (matt white) bezel with either WH (gloss white), BKM (matt black), CR (chrome) or AL (brushed aluminium) - available as accessories.

Dimensions: Ø87 x 77 mm
Luminaire input power: 9.4 W
Luminaire luminous flux: 900 lm
Luminaire efficacy: 96 lm/W
Weight: 0.4 kg



TLG_CHLC_F_74PDB.jpg

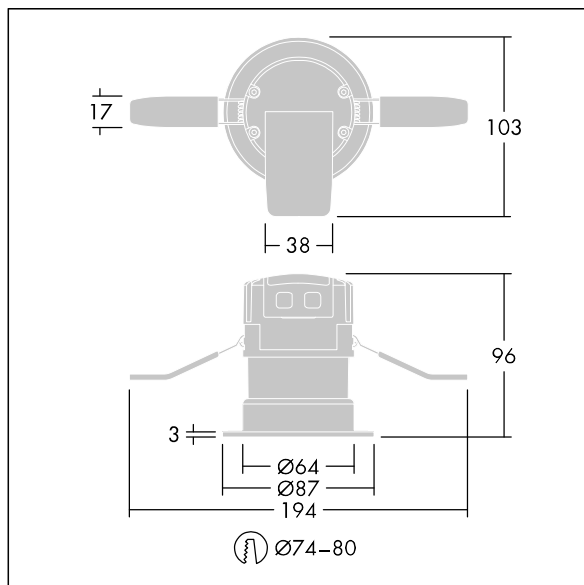

TLG_CH74_M_LDHO.wmf

This product contains a light source of energy efficiency class E.

All values marked with an * are rated values. Thorn uses tried and tested components from leading suppliers, however there may be isolated instances of technology-related failures of individual LEDs during the rated product lifetime. International standards set the tolerance in initial flux and connected load at ±10%. Unless stated otherwise, the values apply to an ambient temperature of 25°C.

Thorn Lighting is constantly developing and improving its products. The right is reserved to change specifications without prior notification or public announcement.
© Thorn Lighting

Chalice 74

96631505 CHAL 74 LED900-830 WFL IP65 WHM

THORN