

A general purpose LED floodlight with Electronic, fixed output control gear. IP65 Class I electrical. Body: die-cast aluminium painted grey. Reflector: anodised aluminium. Lens: toughened stippled glass. Stirrup: Mild steel painted grey. Equipped with PIR presence detector. Complete with 4000K LED

Dimensions: 135 x 59 x 184 mm

Luminaire input power: 17.2 W

Weight: 1.1 kg

Windage: 0.01 m²



TLA_YARD_F_ARCPIR.jpg

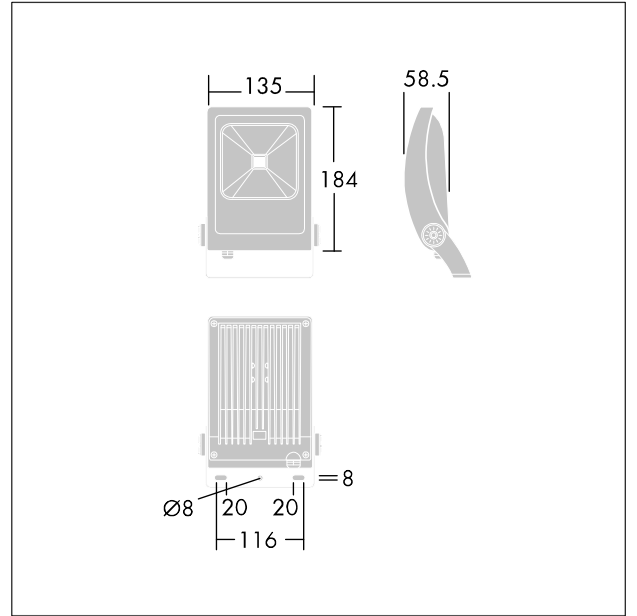

TLA_YARD_M_LD15.wmf

Light Distribution

All values marked with an * are rated values. Thorn uses tried and tested components from leading suppliers, however there may be isolated instances of technology-related failures of individual LEDs during the rated product lifetime. International standards set the tolerance in initial flux and connected load at $\pm 10\%$. Unless stated otherwise, the values apply to an ambient temperature of 25°C.