

A general purpose LED floodlight with Electronic, fixed output control gear. IP65 Class I electrical. Body: die-cast aluminium painted grey. Reflector: anodised aluminium. Lens: toughened stippled glass. Stirrup: Mild steel painted grey. Complete with 4000K LED

Dimensions: 250 x 93 x 390 mm
 Luminaire input power: 54.1 W
 Weight: 4.2 kg
 Windage: 0.01 m²

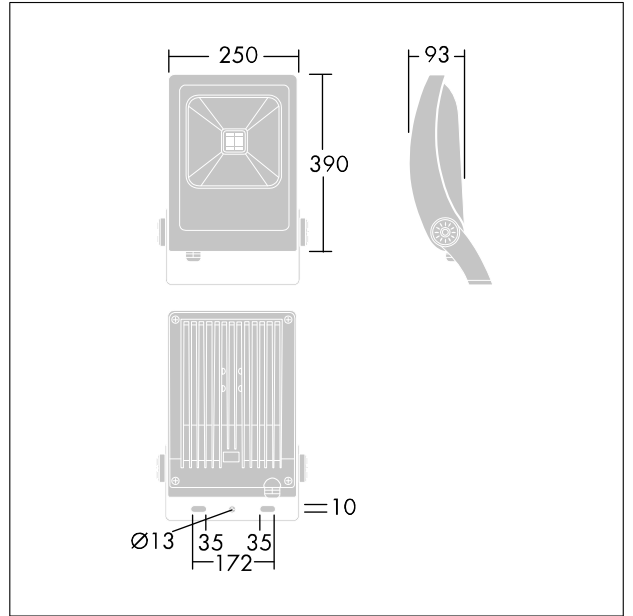

TLA_YARD_F_ARC.jpg



TLA_YARD_M_LD50.wmf

Light Distribution

All values marked with an * are rated values. Thorn uses tried and tested components from leading suppliers, however there may be isolated instances of technology-related failures of individual LEDs during the rated product lifetime. International standards set the tolerance in initial flux and connected load at ±10%. Unless stated otherwise, the values apply to an ambient temperature of 25°C.