



THORN

LIGHTING

TROPHY

Designed for Sports and Area Lighting

ZUMTOBEL Group Member

THE FLOODLIGHT REPLACEMENT OF CHOICE

Trophy is the lightest 2kW equivalent LED flood light in the market. It is an ideal choice for wide-ranging refurbishments of conventional installations – in sports and other areas.



Areas for
controlled
spill light



Recreational
sports



Multi-sports
halls



Transportation
& industrial
areas



Logistics



Car Parks



Coastal
Installation



Feather-Light



For more
information



Lighting for
Sports Module



Sports application
guide

LIGHTING PROJECT FLEXIBILITY

Installation lighting requirements are dependent on the sport and the competitive level.

The higher the level of competition, the greater the requirements.

Designed for flexibility, Trophy covers a broad range of sports lighting needs.

AIMING DEVICE

The aiming device is included in every fitting



FRONT VISOR

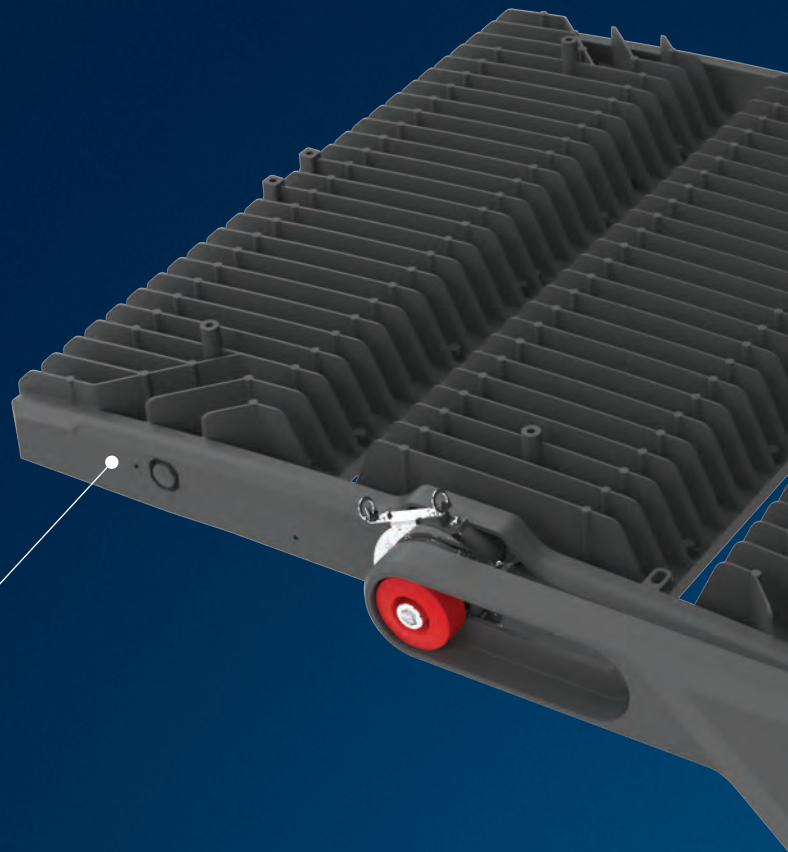
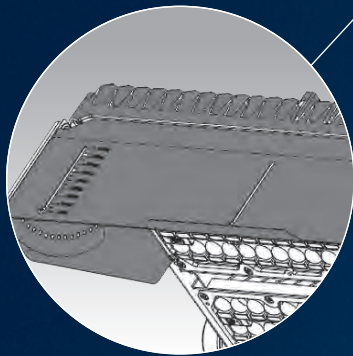

LIGHTING BY DESIGN

Trophy provides a choice of two lumen outputs and two distributions (AS1 and AS2) together with a combination of different louvres/visors accessories to provide excellent illuminance, uniformity and spill control.

Trophy	AS1	AS2
Three modules fitting	200,000 lm	215,000 lm
Two modules fitting	140,000 lm	150,000 lm

DRIVEN TO PERFORM

With its compact IP65 gearbox, Trophy delivers superb performance in all types of installations. Fully controllable over DALI-2, it provides instant, flicker-free lighting while also supporting stepped illumination levels as well as event and dynamic lighting scenarios.

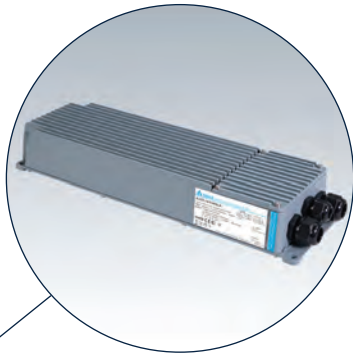

BACK VISOR

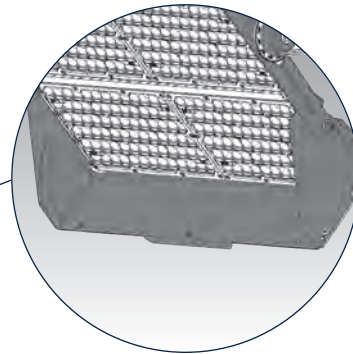

LOUVERS

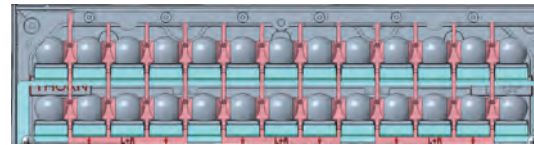

CONTROL UNWANTED LIGHT

Trophy can be equipped with a number of accessories to control unwanted light. Back/front visors and louvers offer excellent spill light control to cover the project requirements.

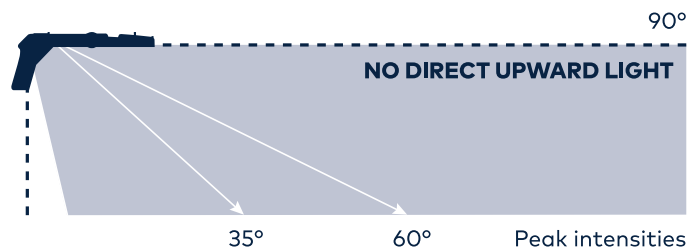

CONNECTION BOX

Connection Box provided with M25 gland. The fitting does not have any exposed cables.

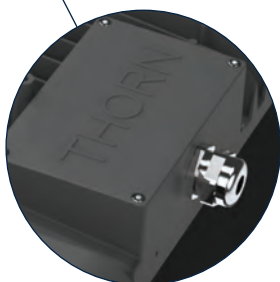



WIE MAN SICH
EINRICHTET
SO LEBT MAN.

hutle

KEEPING LIGHT POLLUTION TO A MINIMUM

Trophy is a genuine asymmetric solution for sports training and area light installations. Combining quality optics with a number of accessories, it focusses light forward with a defined cut-off to help reduce artificial sky glow, glare and intrusive light.

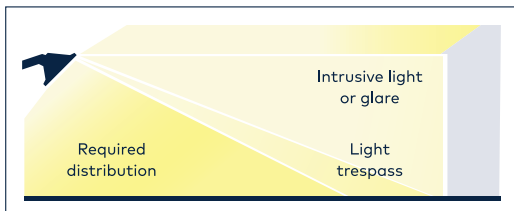

Components of light pollution.

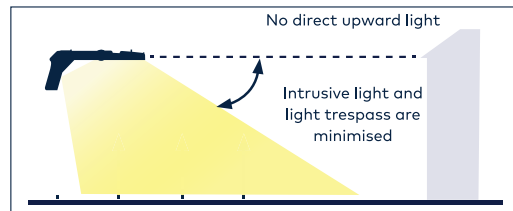

Trophy provides no direct upward light with its asymmetric distribution.





Zurs, AT

LIGHTING WITH TROPHY

During a refurbishment project, it is important to consider the weight and windage of selected products and their suitability for existing or proposed mounting structures.

Note that a floodlight mounted horizontal to the ground, as with an asymmetric distribution, helps to decrease windage and provides better control of spill light.

Trophy three modules installation provides $Scx\ 0^\circ = 0.091\ m^2$ and 22.4 kg.

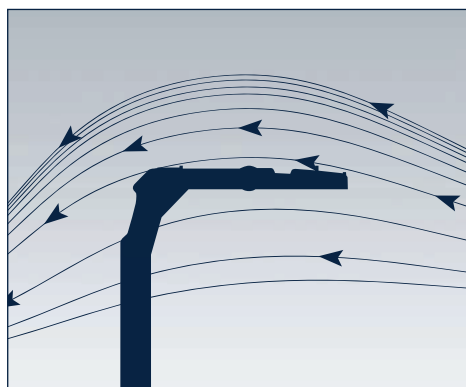

	IP66	AS/NZS 60598	T _a -20 +45	WT (KG)	SAP CODE
Flood lights					
TROPHY 312L757 AS1				17.6	96652485
TROPHY 312L757 AS2				17.6	96652488
TROPHY 468L757 AS1				22.4	96652489
TROPHY 468L757 AS2				22.4	96652490
Control gears					
TROPHY GB IP66 312L105 240-415V CL1 DA				5.1	96652491
TROPHY GB IP66 468L105 240-415V CL1 DA				5.4	96652492
Accessories					
TROPHY BIRD DETERRENT (1 module)					96652800
TROPHY L LOUVRE (1 module)					96652801
TROPHY R LOUVRE (1 module)					96652802
TROPHY B LOUVRE (1 module)					96652803
TROPHY L+R LOUVRE (1 module)					96652804
TROPHY L+B LOUVRE (1 module)					96652805
TROPHY R+B LOUVRE (1 module)					96652806
TROPHY L+R+B LOUVRE (1 module)					96652807
TROPHY VISOR					96652808

INSTALLATION POSSIBILITIES

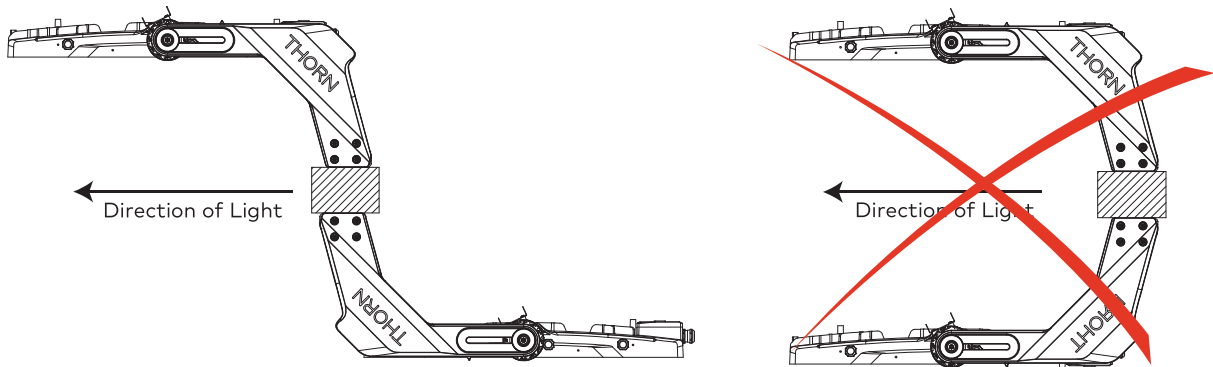

Safety and simplicity are crucial when installing and maintaining a high-powered floodlight at great heights. As a complete lighting solution for both outdoor and indoor spaces, Trophy is ideally suited

for a large variety of mast configurations, mountings and heights. Featuring a lighter, more compact design and improved thermal management, it is now even easier to install.

ACCESSORIES

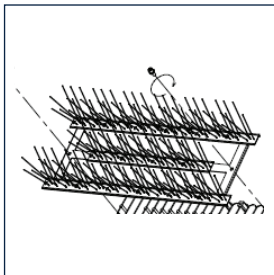

BIRD DETERRENT

Prevents birds from landing on and damaging the floodlight.

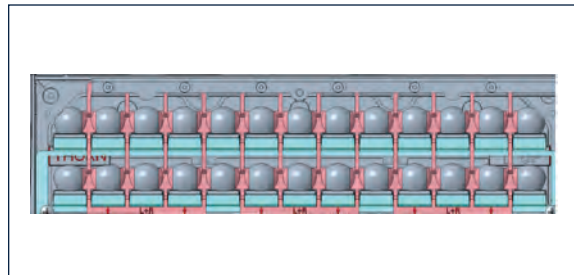

LOUVERS

An add-on to reduce side or back spill.

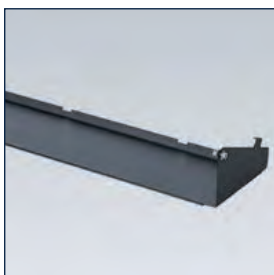

VISOR







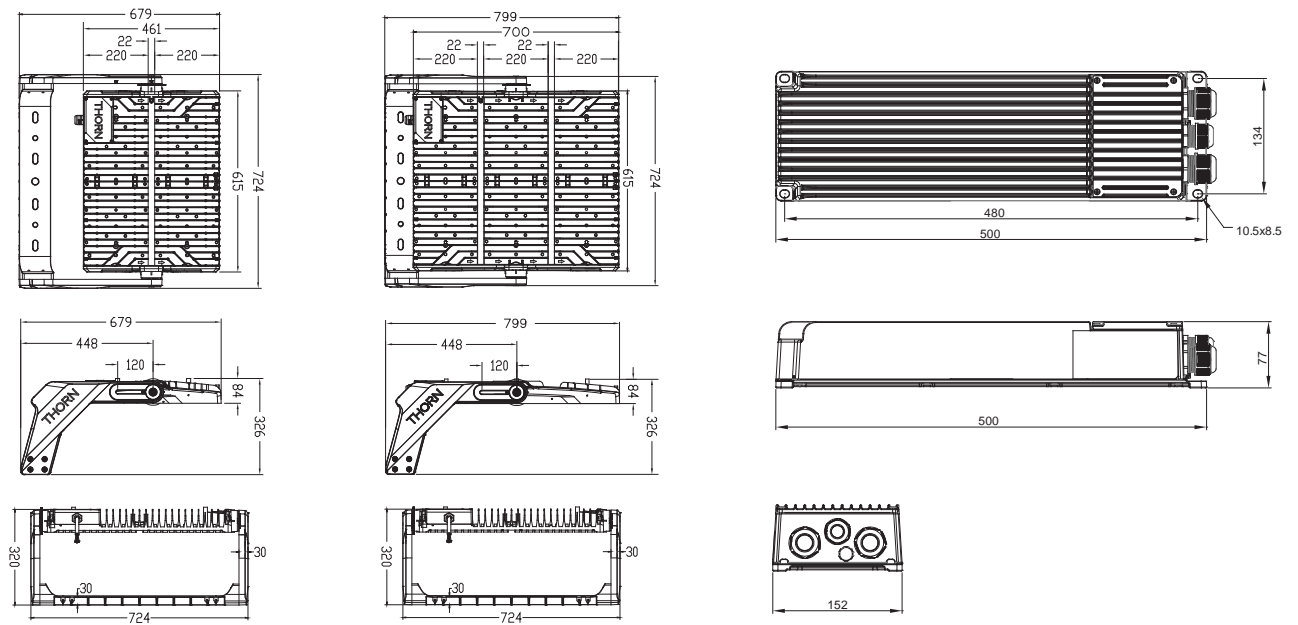







An add-on to deeper reduce front and back spill.



Fremantle, WA - AUS



DISCOVER TROPHY

	468L757 AS1	468L757 AS2	312L757 AS1	312L757 AS2
	205,000 lm	215,000 lm	140,000 lm	150,000 lm
	138 lm/W	148 lm/W	133 lm/W	143 lm/W
	5700 K			
	70			
	IP66			
	-20°C to +45°C			
	IK08			
	10 kV surge voltage protection			
	22.4 kg without gearbox	22.4 kg without gearbox	17.6 kg without gearbox	17.6 kg without gearbox
	Resistant to sea side environment - C5 - EN 44300 (LM6), SS 316 fixings			
	Up to 50 000 h L90B50			
	AS1 - 60°, AS2 - 35°			
	Scx 0° = 0,091 m ²	Scx 0° = 0,091 m ²	Scx 0° = 0,091 m ²	Scx 0° = 0,091 m ²
	Finished in grey (RAL 9007)			
	240V-415V DALI-2			

WE MAKE LIGHT WORK

AUSTRALIA

NSW - Headquarters

ZG Lighting Australia Pty Ltd
2/7 Millner Avenue
Horsley Park, NSW 2175
Australia
T +61 1300 139 965
info.au@zumtobelgroup.com
zumtobelgroup.com

VIC

ZG Lighting Australia Pty Ltd
163 Epsom Road
Flemington, VIC 3031
Australia
T +61 1300 139 965
info.au@zumtobelgroup.com
zumtobelgroup.com

WA

Scope Lighting Pty Ltd
14 Christable Way
Landsdale, WA 6065
Australia
T +61 1300 139 965
info.au@zumtobelgroup.com
zumtobelgroup.com

TAS

Watts Lighting
U4/4 Higson Street
Midway Point, TAS 7171
Australia
T +61 1300 139 965
info.au@zumtobelgroup.com
zumtobelgroup.com

NSW - LIGHT CENTRE

ZG Lighting Australia Pty Ltd
306 Pacific Highway
Crows Nest, NSW 2065
Australia
T +61 1300 139 965
info.au@zumtobelgroup.com
zumtobelgroup.com

QLD

ZG Lighting Australia Pty Ltd
Suite 4B, 51 Alfred Street
Fortitude Valley, QLD 4006
Australia
T +61 1300 139 965
info.au@zumtobelgroup.com
zumtobelgroup.com

SA

ZG Lighting Australia Pty Ltd
South Australia
T +61 1300 139 965
info.au@zumtobelgroup.com

NT

Global Lighting Solutions Pty Ltd
Cnr Mataram St & Coonawarra Rd
Winnellie, NT 0820
Australia
T +61 1300 139 965
info.au@zumtobelgroup.com
zumtobelgroup.com

NEW ZEALAND

AUCKLAND - Headquarters

ZG Lighting (NZ) Limited
27 Jomac Place
Avondale, Auckland 1026
New Zealand
T 0800 800 834
T +64 (9) 828 7155
F +64 (9) 828 7591
info.nz@zumtobelgroup.com
zumtobelgroup.com

WELLINGTON

ZG Lighting (NZ) Limited
Level 2, 225 Thorndon Quay
Pipitea, Wellington 6011
New Zealand
T 0800 800 834
T +64 04 815 8010
F +64 04 499 6058
info.nz@zumtobelgroup.com
zumtobelgroup.com

CHRISTCHURCH

ZG Lighting (NZ) Limited
Unit 6/18 Bernard Street
Addington, Christchurch 8024
New Zealand
T 0800 800 834
T +64 03 366 2485
F +64 03 366 8905
info.nz@zumtobelgroup.com
zumtobelgroup.com

THORN